

COMPONENTS LOCATED IN CUSTOMER CONNECTION AREA

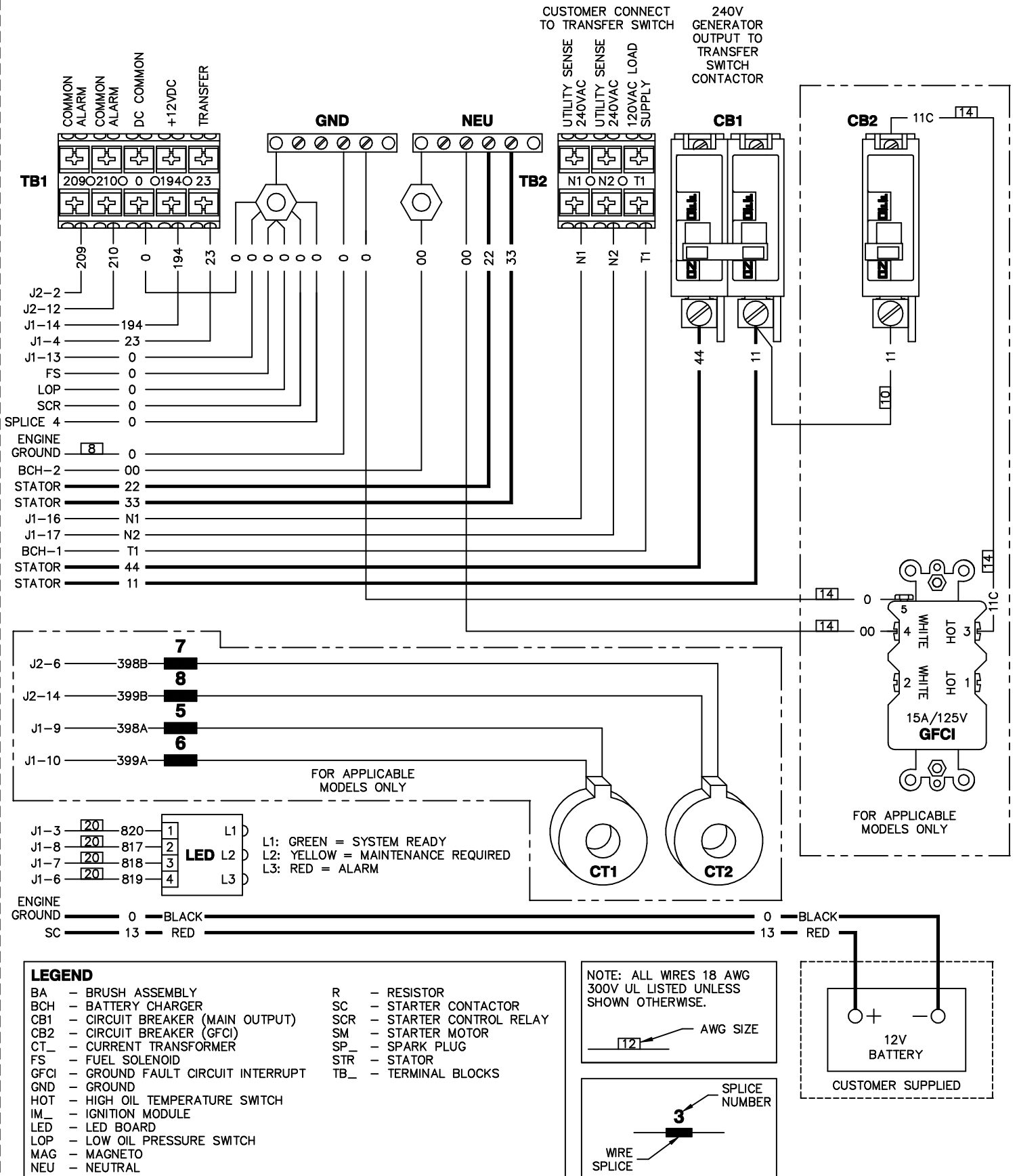

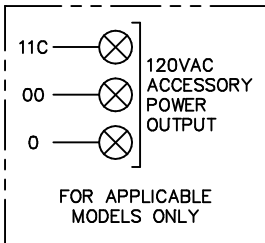

L1: GREEN = SYSTEM READY
 L2: YELLOW = MAINTENANCE REQUIRED
 L3: RED = ALARM

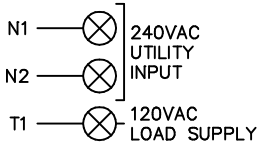
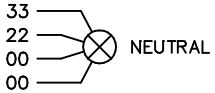
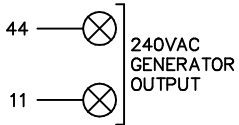
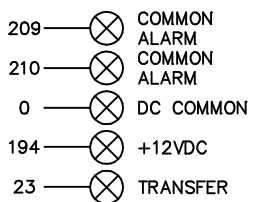
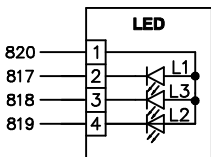

LEGEND	
BA	- BRUSH ASSEMBLY
CB1	- CIRCUIT BREAKER (MAIN OUTPUT)
CB2	- CIRCUIT BREAKER (GFCI)
CT_	- CURRENT TRANSFORMER
FS	- FUEL SOLENOID
HOT	- HIGH OIL TEMPERATURE SWITCH
IM_	- IGNITION MODULE
LED	- LED BOARD
LOP	- LOW OIL PRESSURE SWITCH
R	- RESISTOR
SC	- STARTER CONTACTOR
SCR	- STARTER CONTROL RELAY
SM	- STARTER MOTOR
SP_	- SPARK PLUG